



Doro Leva L21

English



Contents

Overview	1
Congratulations on your purchase	2
Getting started	3
Unbox your new phone	3
Insert SIM card, memory card and battery	3
Charge the phone.....	5
Save energy	6
Turn the phone on and off.....	6
Get to know your phone.....	8
Assistive functions.....	8
Start-up Wizard	8
Phone indicators	8
Notification panel and status bar	8
Descriptions in this document	8
Basic phone operations.....	9
Enter text 	11
Hearing aid compatible	12
Connect the phone to a computer	13
Calls	14
Make a call	14
Call from the phonebook	14
Receive a call	14
Call options.....	14
SOS calls	15
Call information.....	15
Call log	15
Contacts.....	17
Add contact	17
Manage phonebook contacts	17
Manage Top 10	18
ICE (In Case of Emergency) 	19
Assistance button.....	21
Make an assistance call.....	21
Assistance settings	21
Messages	24
Create and send text message (SMS)/picture message (MMS).....	24

Read and handle messages.....	25
Create and send a voice message.....	25
Message settings.....	26
Weather	31
Camera	32
Alarm	34
Torch.....	35
Organiser	36
Calendar	36
Calculator	37
Unit conversion	37
My files.....	37
Media	39
Gallery	39
FM radio	39
Sound recorder	40
Settings.....	41
General	41
Display	43
Security.....	44
Calls	46
Connections.....	48
Sound.....	52
Bluetooth®	53
Start-up Wizard	55
SIM Toolkit	55
Software update.....	55
Additional functions	57
Display status symbols	57
Display main symbols.....	57
Safety instructions.....	58
Network services and costs	58
Operating environment	58
Medical units.....	58
Areas with explosion risk	59
Li-Ion battery.....	59
Protect your hearing	59
Emergency calls.....	60

Vehicles	60
Protect your personal data	60
Care and maintenance	61
Warranty	62
Device OS software warranty	62
Specifications	63
Copyright and other notices	63
Hearing aid compatibility	64
Specific Absorption Rate (SAR)	64
Recycle.....	65
Correct disposal of this product	65
Correct disposal of batteries in this product	65
EU Declaration of Conformity	65
If a power adapter is supplied with your device:	66
UK Declaration of Conformity.....	66

Overview

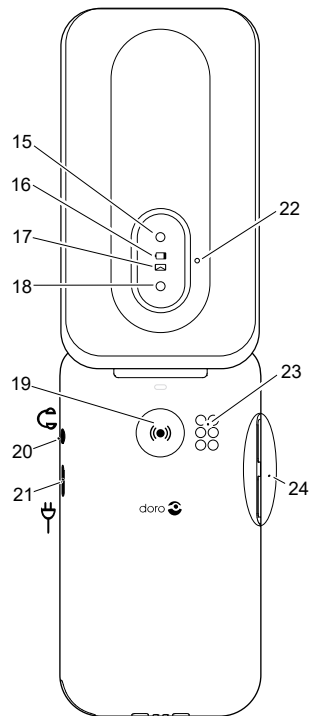
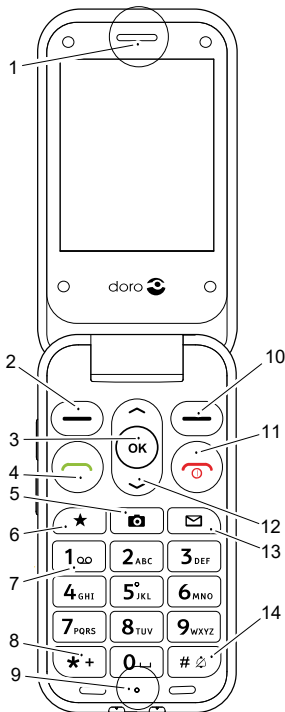

1. Speaker
2. Left selection button
3. **OK**-button
4. Call button
5. Camera shortcut
6. Top 10 favourites
7. Voicemail
8. International prefix/Symbols
9. Microphone
10. Right selection button
11. End call/ **Power on/off**
12. Navigation keys
13. Message shortcut
14. Input method/ Silent mode
15. Camera flash and torch
16. Red light = battery level low / charging
17. Green light = New message / missed call
18. Camera lens
19. Assistance button
20. Headset socket
21. Charging socket
22. Second microphone
23. Loudspeaker
24. Volume keys
25. Charging cradle (optional accessory)

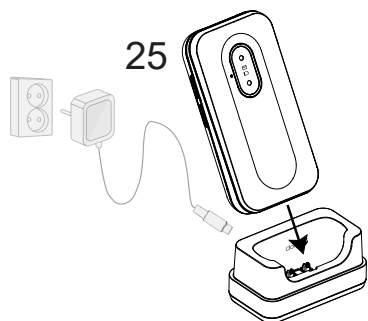

Note! All illustrations may not accurately depict the actual device.

The items supplied with your phone might vary depending on the software and accessories available in your region or offered by your service provider. You can obtain additional accessories from your local Doro dealer or our webshop www.doro.com. The supplied accessories provide the best performance with your phone.

Congratulations on your purchase

Doro Leva L21 is an excellent choice for anyone who wants ease of use and great sound in a stylish clamshell design. Calling, texting and taking pictures are all made easier thanks to well separated, high contrast keys and a large 2.8" screen. Other features include clearer conversations with HD voice, soft touch coating for a more secure grip, splashproof handset and convenient shortcut keys to favourites, camera and messages. There is also an assistance button that can be used to send the user's GPS location and alert up to five trusted friends or relatives if help is needed. And of course, it is compatible with hearing aids (HAC).

For more information about accessories or other Doro products please visit www.doro.com or contact our support.

Getting started

When you get your phone, you will need to set it up before use.

Tip: Remember to remove any screen protector before you start to use your phone.

Unbox your new phone

The first step is to unbox the phone and assess the items and equipment included in the delivery. Make sure to read through the manual so you can familiarize yourself with the equipment and the basic functions.

- The items supplied with the device and any available accessories may vary depending on the region or service provider.
- Appearances and specifications are subject to change without prior notice.
- You can purchase additional accessories from your local Doro retailer.
- Make sure accessories are compatible with the device before purchase.
- Only use batteries and accessories that have been approved for use with this particular model. Connecting other accessories may be dangerous and may invalidate the phone's type approval and warranty.
- Availability of accessories is subject to change depending on manufacturing availability. For more information about available accessories, refer to the Doro website.

Insert SIM card, memory card and battery

The SIM and memory card holder's are located inside the battery compartment. When you insert cards into the card holder, make sure that you do not scratch the metallic contacts on the cards.

Remove the battery cover

IMPORTANT!

Turn off the phone and disconnect the charger before removing the battery cover. Be careful not to damage your fingernails when you remove the battery cover. Do not bend or twist the battery cover excessively as it may get damaged.

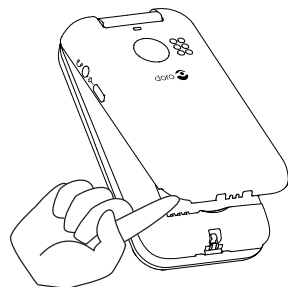

Insert the SIM and memory cards

Insert the nano-SIM (4FF) card by gently sliding it into the SIM card slot. Make sure that the SIM card's contacts are facing inwards and that the cut off corner is as shown.

Take care not to scratch or bend the contacts on the SIM card. Should you need, but have problem to remove/replace the SIM card, use adhesive tape on the exposed part of the SIM card to pull it out.

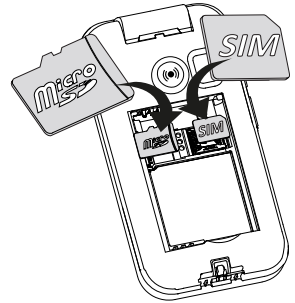

You may optionally install a memory card in the phone to increase the storage space of your phone to be able to store more files, pictures, videos etc. Make sure that the memory card's contacts are facing inwards, as shown above.

IMPORTANT!

This device accepts **nano-SIM card** or **4FF**. Use of incompatible SIM cards may damage the card or the device, and may corrupt data stored on the card.

Use only compatible memory cards with this device. Compatible card types include **microSD**, **microSDHC**, **microSDXC**, max 128 GB.

Incompatible memory cards may damage the card itself, the device and corrupt any data stored on the card.

Insert the battery

Insert the battery by sliding it into the battery compartment.

Replace the battery cover.

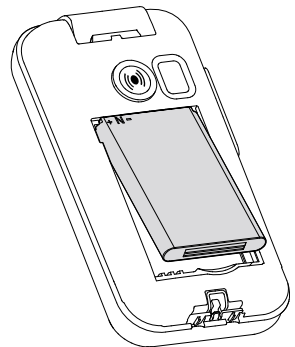





Charge the phone

While it is possible that your phone will already come with enough power to be turned on right out of the box, we recommend charging the device fully before using it.

CAUTION

Only use batteries and accessories that have been approved for use with this particular model. Using unapproved accessories may be dangerous and may invalidate the phone's type approval and warranty.

When the battery is running low,  is displayed and a warning signal is heard. When the charger is connected to the phone,  is displayed briefly, and  when it is disconnected. The battery charge indicator is animated while charging. It takes approximately 3 hours to fully charge the battery. If the phone is turned off when the charger is connected to the phone only the battery charge indicator will be shown on the display. When charging is completed,  is displayed on the screen.

Use a wall power outlet to charge

1. Connect the USB-C connector of the charging cable to the charging socket  on the phone.
2. Put the other end of the charging cable to a USB power adapter which plugs to a wall power outlet.

Use a charging cradle to charge (optional)

1. Connect the USB-C connector of the charging cable to the cradle. Place the phone in the cradle.
2. Put the other end of the charging cable to a power adapter which plugs to a wall power outlet.

Note! To protect the environment we might not provide chargers and USB-cables with all our products. Your device supports charging with a USB-C cable and a USB charger that is compliant with applicable country regulations and international and regional safety standards, such as UKCA or CE. Do not use USB chargers that do not meet applicable safety standards. The power delivered by the charger must be between minimum 0.60 Watts required by the radio equipment, and maximum 2.75 Watts in order to achieve the maximum charging speed. You may use USB chargers with higher power, but it will not increase the charging speed.

The USB-C charging port does not have audio capability and will not support connection of a USB-C headset.

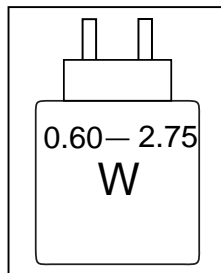

Save energy

When the battery is fully charged, disconnect the charger from the device and unplug the charger from the wall outlet. To save power, the screen turns off after a while. Press any button to wake the screen up. Full battery capacity will not be reached until the battery has been charged 3–4 times. Batteries degrade over time, which means that call time and standby time will normally decrease with regular use. During extended operation, the device may feel warm. In most cases, this is normal.

Turn the phone on and off

1. Press and hold  on the phone to turn it on or off. Press **OK** to power off.
2. If the SIM card is valid but protected with a PIN code (Personal Identification Number), **PIN code:** is displayed. Enter the PIN code and press **OK**. Delete entries with **Clear**.

Attempts: shows the number of PIN attempts left. When no more attempts remain, the SIM card must then be unlocked with the PUK code (Personal Unblocking Key).

Unlock with PUK code

1. Enter the PUK code and press **OK**. Delete entries with **Clear**.
2. Enter a new PIN code and press **OK**.
3. Re-enter the new PIN code and confirm with **OK**.

Note! If PIN and PUK codes were not provided with your SIM card, please contact your service provider. If you enter the wrong PUK code more than 10 times the SIM card gets permanently locked.

Get to know your phone

Assistive functions

Use the symbols below to guide you through supporting sections in the manual.



Seeing



Handling



Hearing



Safety

Start-up Wizard

When starting the device for the first time, a Start-up Wizard will be initiated to set some basic settings.

1. Select the wanted language and press **OK**.
2. Select the type of setting you want to customise. You can choose to adjust just one or more settings by selecting and pressing **OK**. Press **Done** when done.
3. You will be provided a short tutorial of the phone's menu. Press **Next** to step through the tutorial. Press **Finish** to end the tutorial.

Phone indicators

Lights on the phone lid:

- Green light when you have a new notification for a message, missed call, etc.
- Red light when the battery is running low and during charging.

Notification panel and status bar

At the top of the screen you can see if there are any notifications.



Press **OK** to open the main menu to see what applications that have a notification.

Also at the top of the main screen you can see the status symbols, such as network signal strength, battery level, Bluetooth activity and more.

Descriptions in this document

Descriptions in this document are based on your phone's setup at the time of purchase. Instructions normally start from the start screen. Press  to reach the start screen. Some descriptions are simplified.

The arrow (➔) indicates next action in step-by-step instructions.

Tip: If you read this document digitally, you can at any time click on   to go to the table of contents of this document.

Basic phone operations

Call

- Dial a number or answer incoming call.
- Enter the call log.

End call/Power on and off

- End calls or return to the start screen.
- Long press to power on or off.

Options

Press to see more options available in selected menu. In different menus and features it will display available options for that feature. Try to always press this button to explore more options.

Back

Return to the previous screen.

More information

Press to get more information about the options in selected menu.

Assistance

Press to make an assistance call.

Top 10

Press  to access the **Top 10** contact.

Select the wanted contact and press . See also *Manage Top 10*, p.18.

Camera

Press to initiate the camera app and take a picture or a video.

Messages

Press to initiate the messaging app and to send a text (SMS) or picture (MMS) message.

Navigation keys

- (A) Use the **Navigation keys** to navigate.
- (B) Use the **OK** to open the **Menu** and to confirm actions.

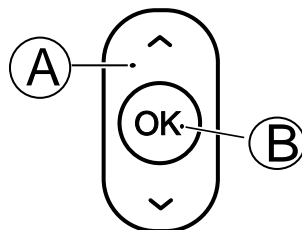

Standby (idle mode)

When the phone is ready to use, and you have not keyed in any characters, the phone is in standby.

Tip: You can always press  to return to standby.



Volume keys

Use the volume keys to adjust the sound volume during a call.

See also *Volume* , p.53 for more information.

Note! If you use a hearing aid or have hearing difficulties when using the telephone in a noisy environment, you can adjust the phone's audio settings, see *Audio setup* , p.52.

Silent mode

You can also set your device to silent mode: press and hold **#** until  appears. To re-enable ring and message tones, press and hold **#** until  disappears. See also *Alert type*, p.53 to switch off notification sounds.

Headset

Note! You must use a headset with a 3.5 mm stereo plug. The USB-C charging port does not have audio capability and will not support connection of a USB-C headset.

When a headset is connected, the internal microphone in the phone is automatically disconnected. If available, use the answer key on the headset to answer and end calls.

CAUTION

Using a headset at high volume may damage your hearing. Adjust the volume level carefully when using a headset.

Enter text

Enter text manually

Select character

- Press a numerical key repeatedly until the desired character is shown. Wait a moment before entering the next character. Press **Clear** to erase characters.

Special characters

1. Press  for a list of special characters.
2. Select the desired character using the **Navigation keys** and press **OK** to enter it.

Move the cursor within text

- Use the **Navigation keys** to move the cursor within the text

Upper case, lower case, numerals and predictive text





- Press  to choose between predictive text, sentence case, lower case, upper case and numerals. To use predictive text the wanted language needs to be selected, see next or *Writing language*, p.42.

Enter text with predictive text

In some languages you can use predictive text input method which uses a dictionary to suggest words. See *Predictive text*, p.42 on how enable/disable the feature.

- Press each key **once**, even if the displayed character is not the one you want. The dictionary will suggest words based on the keys you have pressed.

Example

1. Press , , ,  to write the word “Fred”. Complete the word before looking at the suggestions.
2. Use the **Navigation keys** to move the cursor to view the suggested words.







3. Press **OK** and continue with the next word.
Alternatively, press **0** to insert a space and continue with the next word.
4. If none of the suggested words are correct, use manual input mode.

Note! See *Writing language*, p.42 for more information.

New word means that you can manually enter a word if its not found in the dictionary. The entered word will however not be saved in the dictionary for future use.

Input mode

Press **#** to change input mode.

 En (or the language code for the selected language)	Sentence case with predictive text with first letter in upper case and the following letters in the same word in lower case
 en (or the language code for the selected language)	lower case with predictive text
 EN (or the language code for the selected language)	UPPER CASE with predictive text
 Abc	Sentence case
 abc	lower case
 ABC	UPPER CASE
 123	Numerals
Writing language	Select to change writing language, see also <i>Writing language</i> , p.42

Hearing aid compatible

This phone is hearing aid compatible. Hearing aid compatibility is not a guarantee that a specific hearing aid will work with a specific phone. Mobile phones contain radio transmitters that may interfere with hearing aid performance. This phone has been tested for use with hearing aids, for some of the wireless technologies that it uses, but there may be some newer wireless technologies that have not been tested yet for use with hearing aids. To ensure that a specific hearing aid works well with this phone, test them together before making a purchase.

The standard for hearing aid compatibility contains two types of ratings:

- **M:** To use your hearing aid in this mode, make sure that your hearing aid is set to "M-mode" or acoustic coupling mode, and position the phone receiver near the hearing aid's built-in microphone. For the best results, try using the phone in different positions relative to your hearing aid—for example, placing the receiver slightly above the ear may result in better performance for hearing aids with microphones positioned behind the ear.
- **T:** To use your hearing aid in this mode, make sure that your hearing aid is set to "T-mode" or telecoil coupling mode (not all hearing aids have this mode). For the best results, try using the phone in different positions relative to your hearing aid—for example, placing the receiver slightly below or in front of the ear may result in better performance.

See also *Audio setup* , p.52 on how you can adjust the audio settings.

Connect the phone to a computer

Connect the phone to a computer to transfer pictures and other file types. Start by connecting a USB cable between the phone and computer. From your computer's file explorer, you can drag and drop content between your phone and the computer.

Note! You might not be able to transfer some copyright protected material.

Drag and drop content between phone and a computer

1. Connect your phone to a computer using a USB cable.
2. Wait until the phone or memory card appears as external disks in the file explorer.
3. Drag and drop selected files between the phone and the computer.

Note! You can transfer files using a USB cable on most devices and operating systems supporting a USB Mass Storage interface.



Disconnect the USB cable safely

1. Make sure to enable the hardware to be safely removed.
2. Disconnect the USB cable.

Note! Computer instructions may vary depending on your operating system. See the documentation of your computer's operating system for more information.





Calls

Make a call



1. Enter the phone number including the area code. Delete with **Clear**.
2. Press  to make a call.
3. Press  to end the call.

Tip: For international calls, always use + before the country code for best operation. Press  twice for the international prefix +.

Call from the phonebook

1. Press  to open the phonebook.
2. Scroll through the phonebook, or quick search by pressing the key corresponding to the first letter of the entry, see *Enter text* , p.11.
3. Press **OK** to select an entry and then press  to call the selected entry.
Alternatively, press  to call directly.
4. Press  to cancel the call.



Receive a call

1. Open the phone and press  to answer.
Press  to reject the call (busy signal).
To answer an incoming call by opening the phone, see *Answer mode*, p.48.
2. Press  to end the call.

Tip: Press either of the volume keys to temporarily mute the ring signal during an incoming call.

Call options

Mute



During a call, press  **Mute** to disable the microphone. Press  **Unmute** to re-enable the microphone.

Loudspeaker

During a call, press the right softkey **Speaker** to activate loudspeaker mode. Speak clearly into the phone microphone at a maximum distance of 1 m. Press the right softkey **Speaker** to deactivate loudspeaker mode.

Options

During a call the options button () give access to additional functions.

- **Add call** to call another number. When the second party is connected you can again press  and then press:
 - **Merge calls/Split call conference** to merge the two calls into a conference call and then split them again if needed.
 - **Swap** to swap between the two calls.
 - **Transfer** to merge the two calls and disconnect yourself.
- **Hold call/Retrieve call** to hold/retrieve the current call.
- **Mute** to disable the microphone. See above.
- **End single call** to end the current call (same as )
- **End all calls** to end all current calls.

Note! For settings related to calling, see *Calls*, p.46

SOS calls

As long as the phone is switched on, it is possible to place an SOS call by entering the main local emergency number for your present location followed by .

Some networks accept calls to emergency numbers without a valid SIM card. Contact your service provider for more information.

IMPORTANT!

Mobile phones use radio signals, the mobile phone network, the terrestrial network and user-programmed functions. This means that connection cannot be guaranteed in all circumstances. Therefore, never rely only on a mobile phone for very important calls such as medical emergencies.

Call information

During a call, the outgoing or incoming phone number and the elapsed call time is displayed. If the identity of the caller is withheld or unknown, **Private** or **Unknown** are displayed.



Call log

Received, missed and dialed calls are saved in a combined call log.

1. Press .

Alternatively, press **OK** →  **Call log**.

2. Calls are displayed as follows depending on call type:

	Incoming call
	Outgoing call
	Missed call



3. Select wanted entry and press  to dial.



Alternatively, select an entry and press  to:

- **Details** to show details for the selected call.
- **Call** to call the selected number/contact.
- **Send message** to send a text message.
- **Add to contacts** to save the number to the contacts.
 - **Add to new contact** to add the number as a new contact.
 - **Add to existing contact** to add the number to an existing contact.
- **Add to blacklist/Remove from blacklist** to block/unblock the number. You will not receive calls or messages from a blocked number. See *Blacklist*, p.46.
- **Delete** to delete the selected entry in the call log.
- **Delete all** to delete all entries in the call log.





Contacts

Add contact

1. Press  to open  **Contacts** → **Add contact** and select where to save it.
2. Select **Set picture** and press **OK** to add a picture for the contact.
3. Enter **Name**, **Mobile number**, **Home number**, **Work number** and you may also choose a special ringtone for calls from the selected contact.
4. Press **Save**.

Tip: For international calls, always use + before the country code for best operation. Press  twice for the international prefix +. It is smart to always save your contacts with the initial + before the country code, even for your local/domestic contacts, so you can call them easily even when you are abroad. Press  more times to include the following in the number: **P** (for a 3 second pause in the dialling) or **W** (to wait until you press **Send**).

Manage phonebook contacts

1. Press  to open  **Contacts**.
2. Select a contact and press :
 - **Add contact** to add an entry in the phonebook.
 - **Edit** to edit the contact. When done, press **Save**.
 - **Search contact** to search for a contact.
 - **Add to Top 10** to set the entry as one of the first listed contacts in the phonebook.
 - **Delete** to delete the selected contact. Press **Yes** to confirm.
 - **Delete multiple** to delete multiple contacts. Select or search and select the contacts you want to delete. You can also press  → **Mark all** to select all contacts.
Confirm with **OK** to delete the selected contacts.
 - **Copy contacts** to copy contacts from/to phone and SIM memory.
 - **Copy from:** select from where you would like to copy.
 - **Copy to:** select where the contacts should be copied to.
 - Press **Copy** to select the contacts that should be copied. Use **Mark all** to select all contacts.
 - Press  → **OK** to start copying.

- **Send vCard** to send the selected contact as a vCard via selected method.
 - **Send message** to send a message. See *Create and send text message (SMS)/picture message (MMS)*, p.24.
 - **Owner number** this may be preset by the service provider. If not, you can set the name and number assigned to your SIM card.
 - **Speed dial contacts** to set speed dial numbers to **2** - **9**. Select the wanted speed dial number and add/replace/remove contacts. Press and hold the corresponding key to speed dial.
 - **Memory status** to see status of the phonebook memory.
 - **Import/Export** to copy contacts from/to phone and memory card.
 - **Import contacts** to copy contacts to phonebook from internal memory or SD card. Select from where you would like to import and then select the contacts. Press **OK** to import.
 - **Export contacts** to copy contacts from phonebook to internal memory or SD card. Select the contacts you would like to export and then select where the contacts should be saved.
3. You can also select an individual contact and press **OK**, then press **≡**:
- **Edit** to edit the contact. When done, press **Save**.
 - **Delete** to delete the selected contact. Press **Yes** to confirm.

Manage Top 10

A Top 10 contact is one of the first 10 listed in the phonebook. See *Top 10 ★*, p.9 how to use it.

1. Press **★** and select one of the empty entries and press **Add**.
2. Scroll through the phonebook and press **Select**.
3. If no picture is associated with the selected contact, you will be offered to add one. **Yes** if you want to add a picture, else **No**. Done

To edit or delete an existing entry, select the entry and press **≡ → Change** or **Remove**.



To change view mode, press **≡ → View mode** and select **List** or **Single**.

Tip: View mode → Single can be useful together with an associated picture, if you find it easier to remember a picture instead of a name.

ICE (In Case of Emergency)

First responders can access additional information such as medical information from your phone  **ICE** in case of emergency. In the event of a trauma, it is critical to have this information as early as possible to increase the chances of survival. All fields are optional, but the more information provided the better.

ICE (In Case of Emergency) information can be found in the beginning of your phonebook.

1. Press  to open  **Contacts** →  **ICE**.
2. Press **My details** → **Edit** to add or edit information in each entry.
 - **Name** to enter your name.
 - **Address** to enter your home address.
 - **My number** to enter your phone number.
 - **Birthday** to enter your date of birth.
 - **Language** to enter your preferred language.

When done with **My details**, press **Save**.

3. Press **My health** → **Edit** to add or edit information in each entry.
 - **Condition** to enter any medical conditions or medical devices (e.g. diabetic, pacemaker).
 - **Allergies** to enter any known allergies (e.g. penicillin, bee stings).
 - **Blood type** to enter your blood type.
 - **Vaccination** to enter any relevant vaccination.
 - **Medication** to enter any medication that you are treated with.
 - **Insurance** to enter your insurance provider and policy number.
 - **Doctor** to enter your doctors name.
 - **Phone number** to enter your doctors phone number.

When done with **My health**, press **Save**.

4. Press **ICE contacts** → **Edit** to add or edit information in each entry.

Note! You can add 2 **ICE contacts**.

- **Name** to enter the name of your ICE contact.
- **Relation** add contact from phonebook.
- **Phone number** to enter your ICE contacts phone number.

Repeat the steps for a second ICE contact.

When done with **My details**, press **Save**.

Assistance button

If you need help, the assistance button allows easy access to contact your defined **Helpers**. Make sure that the assistance function is activated and configured before use, enter recipients (**Helpers**) in the numbers list and edit the text message. See *Assistance settings*, p.21.

Make an assistance call

CAUTION

When an emergency assistance call is activated the phone is pre-set to handsfree mode. Do not hold the device near your ear when the handsfree mode is in use, because the volume may be extremely loud.

1. When help is needed, press and hold the assistance button for 3 seconds, or press it twice within 1 second.

The assistance call begins after a delay of 5 seconds. In this time you can prevent a possible false alarm by pressing .

2. An assistance text message (SMS) is sent to all **Helpers**.

Note! This must first be activated to function. See *Assistance SMS*, p.22.

3. The first **Helper** in the list is called. If the call is not answered within a defined time (default is 25 seconds), the next number is called. Calling is repeated 3 times or until the call is answered, or until  is pressed.

Note! Some private security companies can accept automatic calls from their clients. Always contact the security company before using their phone number. Programming '999' into the assistance button is blocked.

Assistance settings

Activation

Activate the assistance function using the assistance button.

1. Press **Menu** → **Assistance** → **Activation**:
 - **On normal** to press and hold the button for approximately 3 seconds, or press it twice within 1 second.
 - **On (3)** to press the button 3 times within 1 second.
 - **Off** to disable the assistance button.

Helpers

Add numbers to the list that is called when the assistance button is pressed.

IMPORTANT!

Always inform recipients in the numbers list that they are listed as your assistance contacts.

1. Press **Menu** → **Assistance** → **Helpers**.
2. Press **Add** → **Manual** to add names/numbers manually.
Alternatively, press **Contacts** to add a contact from the phonebook.
3. Press **Save** to confirm.

Tip: To edit or remove an existing entry, select it with OK. Press **≡** → **Edit** or **Delete as helper**.

Assistance SMS

A text message can be sent to the recipients (**Helpers**) in the numbers list when the assistance button is pressed.

1. Press **Menu** → **Assistance** → **Assistance SMS**.
2. Check **Send SMS** to activate the sending of the assistance message.

Note! It is helpful for the recipient of the assistance message if you include that this is an assistance alert and that it is from you.

Always inform recipients in the numbers list that they are listed as your assistance contact (**Helper**).

Example: "This is an emergency message from John Smith."

3. Scroll down to the message field and write the message.
4. Press **Save** to save the message.

Position SMS

IMPORTANT!

If enabled, Position-SMS will use data services and you may incur additional charges depending on your data plan. We recommend that you check your data plan rates for your subscription with your service provider.

This function sends a text message with the users position to the recipients in numbers list when an assistance call occurs. The message contains date,

time, and the positioning information of the Doro user. If no position can be found the message contains the latest known position.

1. Press **Menu** → **Assistance** → **Position SMS**.
2. Select **On** to activate the sending of the position message.

Signal type

Select the notification signal type for the assistance sequence.

1. Press **Menu** → **Assistance** → **Signal type**:
 - **High** to use loud signals (default).
 - **Low** to use one low signal.
 - **Silent** no sound indication, like a normal call.

Press **OK** to select the desired signal type.

Dialling duration



Select for how long the phone will dial one Helper number before moving on to the next number in the list. Set the dial duration to be shorter than the activation time for an answering service.

1. Press **Menu** → **Assistance** → **Dialling duration**.
2. Select the number of seconds that the phone will dial a Helper number before moving on to the next number in the list. When you are done, press **OK**.



Messages

Create and send text message (SMS)/picture message (MMS)

A text message (SMS) is a short text message that can be sent to other mobile phones. A picture message (MMS) can contain text and media objects such as pictures, sound recordings and video. The messaging settings for most service providers are already included from start.

1. Press **Menu** →  **Messages** → **Write**.
Alternatively, press shortcut button  → **Write**.
2. Press  and select a recipient and number with **Select/OK** from your contacts. Press **Done** when done.
Alternatively, enter number to add recipient manually and press **OK** when done.

Note! If you choose to add multiple recipients, you will be charged for each recipient.

3. Go to the message field and write your message, see *Enter text* , p.11.
4. Press  for more options:
 - **Add picture** to use the camera to take a picture or to add a picture from your gallery.





Note! If you add more than one picture, the following pictures are scaled down by the phone . To keep best picture quality, send only one picture per message.

 - **Add voice message** to add a recorded voice message.
 - **Add video** to use the camera to record a video.
 - **Add subject** to enter a subject.
 - **Add contact** to add a contact as a vcf-file from your phonebook.
 - **Add audio file** to add a recorded audio from your library.
 - **Preview** to preview the message before sending.
 - **Add** to add more items to the message.
 - **Remove attachment** to remove one or more items from the message.
 - **Save as draft** to save the current message for later sending.

5. When done, press **Send** to send the message.





Read and handle messages

Inbox, Drafts, Sent and Outbox

1. Press **Menu** →  **Messages**.
Alternatively, press shortcut button .
2. Select **Inbox, Drafts, Sent** or **Outbox**.
3. Press  for more message options:
 - **Call** to call the selected number/contact.
 - **Details** to view the message details.
 - **Forward** to forward the message. Edit the message (if desired) and enter the recipient, then press **OK** to send.
 - **Delete** to delete that individual message.
 - **Delete all** to delete all messages.
 - **Add to contacts** to save the number to a new or an existing contact.
4. Select an individual message and press **OK** to **Open** the message.
5. Press  for the same options as above and additionally:
 - **Play** to view a multimedia message.
 - **Save media files** to save a media attachment.

Create and send a voice message

A voice message is a short recorded voice message that can be sent to other mobile phones. Length of the voice message is depending on service provider, but typically not more than around 13 seconds.

1. Press **Menu** →  **Messages** → **Voice message**.
Alternatively, press shortcut button  → **Voice message**.
2. A voice recording will start immediately. Speak clearly into the phone microphone at a maximum distance of 1 m.
 - Press **OK** to pause (||) the recording, press **OK** to resume (●) the recording.
 - Press  to stop the recording.
3. Press  and select a recipient and number from your contacts. Press **Done** when done.
Alternatively, enter number to add recipient manually and press **OK** when done.

Note! If you choose to add multiple recipients, you will be charged for each recipient.

4. Go to the message field and write your message, see *Enter text* , p.11.
5. When done, press **Send** to send the message.

Message settings

SMS (text message)

Message center

Text messages requires a message center number, this is normally automatically set on your phone. The number can be obtained from the mobile carrier.

1. Press **Menu** →  **Messages** → **Settings** → **SMS** → **Message center**.
2. Press **OK** and enter the service center number.

Note! The service center number is normally preset on your SIM card and it might not be possible to change.

3. Press **OK** to confirm.

SMS validity period

If the recipient mobile phone is offline, an SMS message is stored temporarily in the SMS center. It is possible to specify the validity period of the SMS. This means that the SMS message will be deleted from the SMS center after some time, and will not be forwarded to the recipient mobile phone when it becomes online.

1. Press **Menu** →  **Messages** → **Settings** → **SMS**.
2. Set **SMS validity period**.

Note! This setting does normally not need to be changed.

Delivery report

You can select if you want the phone to notify you when your text message has reached the recipient.

Note! Contact your service provider for detailed subscription costs before activating.

1. Press **Menu** →  **Messages** → **Settings** → **SMS**.
2. Check **Delivery report** with **OK** to enable.

Preferred storage

Select the preferred storage for your messages.

1. Press **Menu** →  **Messages** → **Settings** → **SMS** → **Preferred storage**.
2. Select to save messages on **Phone** or **SIM**.

SMS reminder

The reminder alerts you once if you haven't checked your messages within 10 minutes from receipt.

1. Press **Menu** →  **Messages** → **Settings** → **SMS**.
2. Check **SMS reminder** with **OK** to enable.

Input method

With Input method you can select to write your text messages with special, distinguishing language specific characters (Unicode) or to write with more simple characters. **Auto** allows special characters. Special characters takes up more space and the size of each message might be reduced to 70 characters. **GSM alphabet** converts any special character to plain alphabet characters, e.g. \hat{I} becomes I. Each message can contain 160 characters.

1. Press **Menu** →  **Messages** → **Settings** → **SMS** → **Input method**.
2. Select the input method:
 - **Auto** (default) to allow special characters if needed, but each message can be limited to 70 characters.
 - **GSM alphabet** to convert any special character to plain alphabet characters.



Memory status

Display the memory space used on the SIM card and in the phone memory.

1. Press **Menu** →  **Messages** → **Settings** → **SMS** → **Memory status**.
2. Display the memory space used on the SIM card and in the phone memory.

MMS (Multimedia/picture message)

Check/uncheck the functions as wanted.

1. Press **Menu** →  **Messages** → **Settings** → **MMS** → **MMS account**:
2. Select your service provider and press **OK** to activate that MMS account.
3. Press  for the following options:



These settings are needed to use the picture messages function. The settings for picture messages is supplied by your service provider and can be sent to you automatically.

- **New connection:** Follow the steps below if your service provider is not in the list. Contact your service provider for correct settings.
 - **Name** to add account name.
 - **Username** to add user name.
 - **Password** to add password.
 - **Access point** to add APN (Access Point Name).
 - **Auth type** to specify the type of authentication to be used if your service provider has an APN with user name and password.
 - **IP type** to specify the protocol which the device must use to access the Internet, through cellular data.
 - **Gateway** to add a gateway proxy address.
 - **Port** to add gateway proxy port.
 - **Homepage** to add homepage.
 - **Advanced settings** for more advanced settings:
 - **DNS address** to add a DNS IP address for your service provider.
 - **Network type** to set the network type. Select between **WAP** and **HTTP**.
 - Press **Save** when done.
 - **Search** to search all available MMS accounts (APN).
 - **Delete** to delete the selected MMS account (APN).
 - **Edit** to edit the selected MMS account (APN).
4. Check/uncheck/select the functions as wanted.
- **Delivery report** to be notified when your multimedia message has reached the recipient.
 - **Request read report** to be notified when your multimedia message has been read by the recipient.
 - **File storage** select to save multimedia files on **Phone** or **Memory-Card** (if installed).
 - **Memory status** to display the memory space used on the selected memory.

Cell broadcast

You can receive messages on various topics from your service provider, such as weather or traffic conditions in a particular region. For available channels and relevant channel settings, contact your service provider. Cell broadcast messages cannot be received when the device is roaming.

Press **OK** to read a cell broadcast message.

1. Press **Menu** →  **Messages** → **Settings** → **Cell broadcast**.
2. You can set the following settings:
 - **Languages** to select for what languages broadcast messages should be displayed.
 - **Channel settings** for channel settings:
Check related channel to receive messages on that channel.
Press  for channel handling:
 - **Add channel** to add a new channel to receive broadcast messages on. Set channel number, title and press **Save** to save and activate it.
 - **Edit channel** to edit the selected channel and press **Save** when done.
 - **Delete channel** to delete the selected channel and press **Yes** to confirm.
3. Press  for options:
 - **Forward** to forward a message.
 - **Delete** to delete a message.
 - **Settings** for more options:

Note! Not all operators have the cell broadcast messaging function activated in their network.

Emergency alert

Emergency alert is the generic term for the Public Warning Service based upon **Cell broadcast** technology. You will receive a message if an authority sends an alert message. This service is not available in all countries.

Inbox

1. Press **Menu** →  **Messages** → **Settings** → **Emergency alert**.
2. Select **Inbox**.

-
3. Press **≡** for the following options, but the options might differ depending on selected type of messages:
 - **View** to open and view the selected message.
 - **Delete** to delete that individual message.
 - **Delete all** to delete all messages.

Settings

Select the type of alert messages that you want to receive.

1. Press **Menu** →  **Messages** → **Settings** → **Emergency alert** → **Settings**.
2. Enable/disable message type with **OK** button.

Set Voice mail

If your subscription includes an answering service, callers can leave a voice-mail message when you are unable to answer a call. **Voice mail** is a network service and you may need to subscribe to it first. For more information and for the voicemail number, contact your service provider.

Call voicemail

- Press and hold shortcut button **1**.
1. Press **Menu** →  **Messages** → **Settings** → **Voice mail**.
 2. Press **Edit** and enter number and press **OK** to confirm.

Weather

IMPORTANT!



The weather function uses data services that can be costly. We recommend that you check your data rates with your service provider.

View the weather for your chosen city.

1. Press **Menu** →  **Weather**.
2. Press  to return to standby mode.

Note! In order to see the weather, you must first select a city.







Weather settings

1. Press **Menu** →  **Weather**.
2. Select **Weather**: The first time you open the weather function, you will be requested to enter the city nearest to you for your weather forecasts. Enter the name of the city and press **Search** to search. Select the city in the list and press **OK**.
3. Press  for options.
 - **City**: press  and **Edit** to edit or **Delete** to delete the city.
 - **Wallpaper** and select **On** (to view the weather in standby mode).
 - **Temperature unit** to select between **Celsius** and **Fahrenheit**.

Camera

You can take photos, record videos and view your photos and videos using the camera menu.

To get sharp photos and videos, wipe the lens clean with a dry cloth.

1. Press shortcut button .
Alternatively press **Menu** →  **Camera**.
2. Use / to zoom in and out.
Note! Zoom may reduce picture quality.
3. Press  or the **OK** to take photo or start/stop video recording.
4. For video recording, press **II (OK)** to pause and  to stop the recording. Press **Yes** to save the recording.
5. Press  for more options:

Note! Some options are only available in photo mode and some in video mode.

Image viewer

- The Image viewer displays all your taken photos and recorded videos in the gallery. See more at *Gallery*, p.39.

Flash

- **Auto** to automatically use the flash/lamp depending on the surrounding light.
- **Off** to force the flash/lamp to off regardless of the surrounding light.
- **On** to force the flash/lamp to on regardless of the surrounding light.

Note! The flash setting made will remain until you change it.

Camera/Video camera

- Switch between camera and video recording.

Quality

- Set the level of quality for the video. The higher, the better quality.

Note! Higher quality will consume more memory capacity.

Shutter sound

- Select to have the **Shutter sound** on or **Off**.



Preferred storage

- **Phone** to save pictures or videos on the phone memory.
- **MemoryCard** to save pictures or videos on the memory card.

Note! This option is only available when a compatible external memory is inserted in the device. See *Insert SIM card, memory card and battery*, p.3.

Alarm

Note! The alarm will work even if the phone is turned off.

1. Press **Menu** →  **Alarm**.
2. Press  → **Add** for a new alarm.
3. Select and set the different options:
 - Set the alarm **On** or **Off**.
 - Set the time for the alarm.
 - Set the options for **Repeat mode** if the alarm should be repeated.
 - **Once** for a single occurrence of the alarm.
 - **Daily** for daily repetition of the alarm.
 - **Working days** check to repeat the alarm for the selected day(s) of the week.
 - Set a name for the alarm.
 - Select ringtone to associate with the alarm.
4. Press **Save**.

If you already have an alarm entry, you can simply **Enable/Disable** the alarm with **OK**.

Snooze or turn off

- When the alarm goes off a signal will sound. Press **OK** to turn off the alarm or press  to snooze and repeat the alarm after 9 minutes.

Tip: To edit or delete an alarm, select the alarm and press  → **Edit** or **Delete**.

Torch

Note! The torch can drain the battery quickly. Remember to turn off the torch after use. The light will switch off automatically after 5 minutes.

1. From idle screen, press **Menu** →  **Torch**.
2. Press **OK** to turn it off/on.

Tip: You can longpress **0** to activate/deactivate the torch.

Organiser



Calendar

Note! Calendar reminders will work even if the phone is turned off.

Snooze or turn off

- When the calendar reminder goes off a signal will sound, if set. Press **OK** to turn off the reminder or press  to silence the reminder.

Add calendar event

1. Press **Menu** →  **Organiser** →  **Calendar**.
2. Select a date and press **OK** for the following options:
 - **Subject** to enter a event name and other relevant text.
 - Set the date.
 - Set the time.
 - Set the reminder ringtone.
 - Set the options for **Repeat mode** if the event should be repeated.
 - **Once** for a single occurrence of the event.
 - **Daily** for daily repetition of the event.
 - **Weekly** check to repeat the event for the selected day(s) of the week.
 - **Monthly** for monthly repetition of the event.
 - **Yearly** for yearly repetition of the event.
 - **Off** to turn off the repetition of the event.
3. Press **Save** when done.

Tip: To edit or delete an event, select the event and press  → **Edit** or **Delete**.

Calendar options









Press **Menu** →  **Organiser** →  **Calendar** →  :

- **Add/New event**, then enter your required information. See *Add calendar event*, p.36.
- **View** to view events for the day.
- **View All** to view all events.
- **Clear/Delete** to delete the events for the day.
- **Clear all/Delete all** to delete all events.

- **Go to date** to go to a date.
- **Weekly** for a weekly view.
- **Daily** for a daily view.
- **First day of week** to set the day when the week should start.

Calculator



The  **Calculator** can perform basic mathematical operations.

1. Press **Menu** →  **Organiser** →  **Calculator**.
2. Enter the first number.
Use  for decimal character and  to toggle between positive and negative number.
3. Use the navigation key to select an operation (, , , ).
4. Enter the next number.
5. Repeat steps 2–4 as wanted and complete the calculation with .



Unit conversion



Use  **Unit conversion** to convert between the various units of measurement.

1. Press **Menu** →  **Organiser** →  **Unit conversion**.
2. Select the wanted type of unit.
3. Select the unit pair you would like to convert between.
4. Enter the value for the known unit and the equivalent value will instantly be displayed for the other unit.

My files

Manage the contents and properties of files.

The files are normally stored in the folders corresponding to the type of file.



1. Press **Menu** →  **Organiser** →  **My files**.
2. Select **Phone** or **MemoryCard**.
3. Select a folder, e.g. **Photos** and press **OK** to open it.
4. Select a file and press **OK** to open the file.

5. Press  to see the available options.

Media

Gallery

View and manage your saved pictures and videos.

1. Press **Menu** →  **Media** →  **Gallery**.
2. Select a photo/video and press **OK** to view the photo or play the video.
3. Press  for options.
 - **Send** to send a picture/video via MMS or Bluetooth.
 - **Delete** to delete the selected item. Press **OK** to confirm.
 - **Use** to use a photo as **Wallpaper** or **Contact Picture**.
 - **Rename** to rename. Edit the name and press **Save**.
 - **Details** to view detailed information about the file, e.g. date, size, type.

FM radio





The  **FM radio** has a frequency range from 87.5 to 108.0 MHz. To listen to the radio you need to connect a compatible headset that works as antenna.

Turning the radio on/off

1. Connect a headset to the headset socket .
2. Press **Menu** →  **Media** →  **FM radio** → **OK** to turn the radio on (▶) / off (■). The tuned frequency is displayed.

Tip: Press  to return to standby mode. The radio will continue to play. Disconnecting the headset will turn off the radio.







Options

1. Press **Menu** →  **Media** →  **FM radio**.
2. The phone will automatically search for available radio stations.
3. Switch between stations with ◀◀ or ▶▶.
4. Press  for options:
 - **Auto save channels** to search for available radio stations.
 - **Channel list** to see your saved channels. Press **OK** to play channel and  for more options:
 - **Play** to play channel.
 - **Edit** to edit channel name and frequency.

- **Delete** to delete channel.
- **Delete all** to delete all channels.
- **Save channel** to save the currently set frequency.
- **Manual search** to manually set the frequency.
- **Speaker on** to play the channel on the speaker.
To turn off the speaker, press  → **Speaker off**.

Sound recorder

Use the sound recorder to record notes and messages.

1. Press **Menu** →  **Media** →  **Sound recorder**.
2. Press  to start and  to pause recording. Press  when done.
The recording is automatically saved.
3. Press  for options:
 - **New recording** to start a new recording.
 - **Delete** to delete the current recording.
 - **Send** to send the recording via MMS or Bluetooth.
 - **Recordings** for the list of recordings and press **OK** to play the recording. Press  for options:

Note! Audio recordings are stored in **Phone** → **Audio**

- **Add folder** to add a folder.
- **Set as ringtone** to use the recording as ringtone for incoming calls or as alarmtone.
- **Send** to send the recording via MMS or Bluetooth.
- **Delete** to delete the current recording.
- **Details** to view detailed information about the file, e.g. date, size, type.
- **Edit** to rename the recording.
- **Search** to search for a recording.
- **Sort** to change the sorting order for the recordings.
- **Mark** to select/unselect one or multiple recordings for different actions. Press  for different options.

Settings

General

Time & date

Tip: The phone is set to automatically update time and date according to current time zone. To turn off, uncheck **Time & date** → **Automatic date & time** → **Use network-provided time**. Automatic update of date and time does not change the time you have set for the alarm clock or the calendar. They are in local time.

Set time

1. Press **Menu** → **Settings** → **General** → **Time & date** → **Set time**.
2. Enter the time and press **OK**.

Note! Setting the time manually will turn off the automatic time and date update.

Set date

1. Press **Menu** → **Settings** → **General** → **Time & date** → **Set date**.
2. Enter the date and press **OK**.

Note! Setting the date manually will turn off the automatic time and date update.

Time format

1. Press **Menu** → **Settings** → **General** → **Time & date** → **Time format**.
2. Select **12 hours** or **24 hours** and press **OK**.

Date format

1. Press **Menu** → **Settings** → **General** → **Time & date** → **Date format**.
2. Select the wanted format and press **OK**.

Set automatic time and date update

1. Press **Menu** → **Settings** → **General** → **Time & date** → **Automatic date & time**.
2. Check **Use network-provided time** to automatically update time and date according to current time zone.

Note! Setting the time or date manually will turn off the automatic time and date update.

3. Press **Update now** to update the time and date.

Language

The default language for the phone menus, messages, etc. is determined by the SIM card. You can change this to any other language supported by the phone.

1. Press **Menu** → **Settings** → **General** → **Language** → **Language**.
2. Select a language and press **OK**.

Writing language

1. Press **Menu** → **Settings** → **General** → **Language** → **Writing language**.
2. Select a language and press **OK**.

Predictive text

Use predictive text input method to have a dictionary suggest words. Press corresponding key **once**, even if the displayed character is not the one you want. The dictionary will suggest words based on the keys you have pressed. See *Enter text with predictive text*, p.11 on how to use it.

1. Press **Menu** → **Settings** → **General** → **Language** → **Predictive text**.
2. Select the feature to be **On** or **Off**.

Battery

Battery Level

See your battery status.

1. Press **Menu** → **Settings** → **General** → **Battery** → **Battery Level**.
2. See the current battery status.

Battery care

Activate to prolong the battery life time. When active, charging will stop at 80% to reduce the deterioration of the battery.

1. Press **Menu** → **Settings** → **General** → **Battery** → **Battery care**.
2. Select the feature to be **Off** or **On**.

Block function

Select an app or function you want to block for usage.

1. Press **Menu** → **Settings** → **General** → **Block function**.
2. Uncheck each app/function you want to disable and check to enable blocking.

3. Press **Done** when done.

Reset settings

1. Press **Menu** → **Settings** → **General** → **Reset settings**.
2. All the changes that you have made to the phone settings will be reset to default settings.
If set, enter the phone code and press **OK** to reset.

Reset all

1. Press **Menu** → **Settings** → **General** → **Reset all**.
2. All phone settings and content such as contacts, photos, number lists and messages will be deleted (SIM card and memory card are not affected).
If set, enter the phone code and press **OK**.
3. Press **Yes to Reset all** to confirm and continue to delete all your personal information.

Note! This action cannot be undone!

Display

Wallpaper

1. Press **Menu** → **Settings** → **Display** → **Wallpaper**.
2. Select wallpaper from:
 - **Static wallpaper** for predefined available wallpapers.
 - **More pictures** for images available among your files.

Brightness

You can adjust the brightness of the display.

1. Press **Menu** → **Settings** → **Display** → **Brightness**.
2. Set the brightness to comfortable level and press **OK** when done.

Note! The brighter the display is, the more battery power it will consume.

Backlight

Select the delay time for the display backlight.

1. Press **Menu** → **Settings** → **Display** → **Backlight**.
2. Select the how long time the display is lit.
3. Press **OK** to confirm.

Note! Longer time with backlight activated will consume more battery power.

Main menu

You can select different styles for the main menu.

1. Press **Menu** → **Settings** → **Display** → **Main menu**:
2. Select **Single** or **List**.

Font size

You can adjust the text size for the menu and messages.

1. Press **Menu** → **Settings** → **Display** → **Font size**.
2. Select **Normal** or **Big**.

Theme

You can select different themes to adjust the phone's texts and background.

1. Press **Menu** → **Settings** → **Display** → **Theme**.
2. Select the wanted theme and press **OK**.

Security

PIN

1. Press **Menu** → **Settings** → **Security** → **PIN**.
 - Check **PIN** to activate the PIN code. You need to enter the PIN code every time the phone is started.
 - Uncheck **PIN** to deactivate the PIN code.

IMPORTANT!

If you deactivate the PIN code and the SIM card is lost or stolen, it is unprotected and must be blocked by your service provider.

2. Press **Modify PIN** to change you SIM PIN code.
3. Enter the current PIN and press **OK**.
4. Enter new PIN and press **OK**. Enter new PIN again and and press **OK**.
When done, **Succeeded** will appear.

Modify PIN2

1. Press **Menu** → **Settings** → **Security** → **Modify PIN2**.
2. Enter the current PIN2 and press **OK**.

3. Enter new PIN2 and press **OK**. Enter new PIN2 again and and press **OK**. When done, **Succeeded** will appear.

Phone lock

The phone lock protects your phone from unwanted usage. If activated, phone is locked after restart and the phone code needs to be entered to unlock.

1. Press **Menu** → **Settings** → **Security**.
2. Check **Phone lock** to enable phone lock.
3. Enter current phone code and press **OK**.

Note! You need to enter current phone code.

Modify Phone code

1. Press **Menu** → **Settings** → **Security** → **Modify Phone code**.
2. Enter current code and press **OK**.
3. Enter new code and press **OK**.
4. Confirm new code and press **OK**.

Fixed dialling number (FDN)

You can limit calls to certain numbers saved on the SIM card. The list of allowed numbers is protected by your PIN2-code.

Note! The PIN2-code is needed to apply fixed dial. Contact your service provider to get the PIN2-code.

1. Press **Menu** → **Settings** → **Security** → **Fixed dialling number**:
2. Check **Fixed dialling mode** → enter PIN2 to enable the feature.
3. Press **Fixed dialling number** → **≡** to add and enter the first allowed number. You can add more numbers or edit or delete existing.

Note! You can save parts of phone numbers. For example, if you save 01234, allows calls to all numbers starting with 01234. It is possible to place an SOS call by entering the main local emergency number followed by  even when fixed dial is activated. When fixed dial is activated you are not allowed to view or manage any phone numbers saved on the SIM card. You are not able to send any text messages either.

Blacklist

You can compile a blacklist of phone numbers so that any phone number on your blacklist is blocked when calling or texting you.

Add blacklist numbers

1. Press **Menu** → **Settings** → **Security** → **Blacklist** → **Blacklist**.
2. Press **≡** for options.
 - **New** to add a number to list of blocked numbers. Enter name and number or add from **👤 Contacts**. Press **Save** to confirm.
 - **Edit** to edit the number.
 - **Delete** to delete the number.
 - **Import contacts** to import contacts from phonebook.
 - **Delete all** to delete all numbers.

Blacklist settings

1. Press **Menu** → **Settings** → **Security** → **Blacklist** → **Blacklist settings**.
 - Check **Audio call interception** to enable blacklist blocking for incoming calls.
 - Check **Message interception** to enable blacklist blocking for incoming messages.

Whitelist

Select to only accept incoming calls from contacts saved in the phonebook.

Note! If enabled and no numbers are in the phonebook, no calls can be received.

1. Press **Menu** → **Settings** → **Security** → **Whitelist**.
2. Press **Activation** and select **On** to activate. Press **OK** to confirm.

Calls

Call divert

You can divert calls to an answering service or to another phone number. Select a call condition, press **Activate** and then select whether to divert call to voicemail or enter number to activate the call diversion. You can also select **Off** to deactivate or **Check status**.

1. Press **Menu** → **Settings** → **Calls** → **Call divert**:

- **Call forwarding unconditional** to divert all voice calls.
- **Call forwarding on busy** to divert incoming calls if the line is busy.
- **Call forwarding on no reply** to divert incoming calls if unanswered.
- **Divert if unreachable** to divert incoming calls if the phone is turned off or out of range.
- **Cancel all diverts** to cancel all diverts.

Call waiting

You can handle more than one call at a time, put the current call on hold and answer the incoming call. When activated, an alert tone is heard if there is an incoming call while talking.

- During a call, press  to answer the second call. The phone will automatically hold the first call. For more call handling, see *Call options*, p.14.

Activate call waiting

Press **Menu** → **Settings** → **Calls** → **Call waiting**:

- Press **Activate** to enable call waiting.
- Press **Cancel** to disable call waiting.
- Press **Check status** to check the status of call waiting.

Call barring

Your phone can be restricted to block certain types of calls. Select a condition and press **Activate** to activate the barring. You can also select **Off** to deactivate or **Check status**.

Note! PIN2 is needed to apply call barring. Contact your service provider to get the PIN2.

1. Press **Menu** → **Settings** → **Calls** → **Call barring**.
2. Mark the type of calls that you want to restrict:
 - **All outgoing calls** to block all outgoing calls, but be allowed to answer incoming calls.
 - **All incoming calls** to block all incoming calls, but be allowed to make outgoing calls.
 - **Incoming calls when roaming** to block incoming calls when roaming (operating in other networks).

- **International outgoing calls** to block outgoing calls to international numbers.
 - **International outgoing call while roaming** to block outgoing calls to international numbers while roaming (operating in other networks).
 - Press **Cancel all barring** to cancel all call barring.
3. Press **OK** to confirm.

Caller ID

Display or hide your phone number on the recipient's phone when you call.

Press **Menu** → **Settings** → **Calls** → **Caller ID**:

- **Hide ID** to never show your number.
- **Send ID** to always show your number.
- **Set by network** to use default setting by the network.

Answer mode

1. Press **Menu** → **Settings** → **Calls** → **Answer mode** → **Open to answer**:
2. Press **On** to answer incoming calls by opening the phone. Press **Off** to disable the function.

Any key answer

1. Press **Menu** → **Settings** → **Calls** → **Any key answer**.
2. Press **On** to be able to answer incoming calls by pressing any button, (except ). Press **Off** to disable the function.

Connections

Flight mode

In **Flight mode** you cannot make or receive calls or do anything that requires a network connection, this is to prevent disturbance to sensitive equipment.

When you take your phone abroad, you can keep it in flight mode. If you do that, there's no chance of data roaming charges. Enable **Flight mode** when in areas with no network coverage to save battery since the phone repeatedly scans for available networks and this consumes power. You can be notified by alarms, if alarms are activated.

1. Press **Menu** → **Settings** → **Connections** → **Flight mode**.

2. Press **On** to activate it. Press **Off** to deactivate.

Network account

The network account has the Access Point Name (APN) which is the name of a gateway between a mobile network and another computer network, mostly the public Internet. The APN settings are used by services that communicates using other computer networks. The APN settings for most major service providers are already included from start.

Follow the steps below if your service provider's profile is not in the list or if you need to change any setting. Contact your service provider for correct settings.

1. Press **Menu** → **Settings** → **Connections** → **Network account**:
2. Select your service provider and press **OK** to activate that network account.
3. Press **≡** for the following options:

These settings are needed to use the picture messages function. The settings for picture messages is supplied by your service provider and can be sent to you automatically.

 - **New connection**: Follow the steps below if your service provider is not in the list. Contact your service provider for correct settings.
 - **Name** to add account name.
 - **Username** to add user name.
 - **Password** to add password.
 - **Access point** to add APN (Access Point Name).
 - **Auth type** to specify the type of authentication to be used if your service provider has an APN with user name and password.
 - **IP type** to specify the protocol which the device must use to access the Internet, through cellular data.
 - **Gateway** to add a gateway proxy address.
 - **Port** to add gateway proxy port.
 - **Homepage** to add homepage.
 - **Advanced settings** for more advanced settings:
 - **DNS address** to add a DNS IP address for your service provider.
 - **Network type** to set the network type. Select between **WAP** and **HTTP**.

- Press **Save** when done.
- **Search** to search all available network accounts (APN).
- **Delete** to delete the selected network account (APN).
- **Edit** to edit the selected network account (APN).

Data service

Use data service to access mobile data services.

IMPORTANT!

Using mobile data services can be costly. We recommend that you check your data rates with your service provider.

Enable data service for services like software update. Uncheck to avoid data charges.

1. Press **Menu** → **Settings** → **Connections**.
2. Check **Data service** to activate it or uncheck to deactivate.

Data service counter

The **Data service counter** gathers traffic information from all apps using mobile data. You can keep track of the amount of data transferred to and from your device over the mobile network since last reset.

1. Press **Menu** → **Settings** → **Connections** → **Data service counter**.
2. See mobile data usage since last reset as well as total usage.
3. Press **Reset** to reset the mobile data usage counter and press **Yes** to confirm.

Data roaming

Your phone automatically selects your (service providers) home network if within range. If you are abroad or your home network is not within range, you can use another network, provided your network operator has an agreement that allows you to do so. This is called roaming. Contact your service provider for more information.

1. Press **Menu** → **Settings** → **Connections**.
2. Check **Data roaming** to activate it or uncheck to deactivate.

IMPORTANT!

Using data services while roaming can be costly. Contact your service provider for data roaming rates before you use data roaming.

Network selection

Your phone automatically selects the network operator that you have a subscription with. When roaming or if you otherwise have no signal you can try to manually select a network.

1. Press **Menu** → **Settings** → **Connections** → **Network selection**.
2. Select **Auto select** to select network automatically or **Manual select** to select network manually and a list of available network operators is displayed (after a short delay). Select desired operator and press **OK**.

IMPORTANT!

If you select a network manually, your phone will lose network connection when the selected network is out of reach. Remember to set **Auto select**.

Network type

Your phone automatically switches between the mobile networks that are available where you are. You can also manually set your phone to use a specific mobile network type. Different status icons are displayed in the status bar depending on the type of network that you are connected to.

Press **Menu** → **Settings** → **Connections** → **Network type**:

- **4G/3G/2G**: to automatically switch for best service between 2G, 3G and 4G.
- **3G/2G**: to automatically switch for best service between 2G and 3G.
- **2G**: for 2G service only.

IMPORTANT!

If you set your phone to use **3G/2G** or **2G**, you will not be able to make any calls, including emergency calls, or use other features requiring a network connection, if the selected network type is unavailable.

VoLTE

Set if voice calling over LTE (4G) network should be enabled or disabled. This menu is only visible if your service provider supports the feature.

1. Press **Menu** → **Settings** → **Connections** → **VoLTE**.
2. Check **SIM** to activate it.

Note! Your network operator also needs to support this feature.

Sound

Audio setup

If you use a hearing aid or have hearing difficulties when using the device in a noisy environment, you can adjust the audio settings.

Tip: Already at the age of 50 it is normal to have a hearing loss at the high frequencies, so why not try our optimised sound profile called **Doro ClearSound**.

1. Press **Menu** → **Settings** → **Sound** → **Audio setup**:
 - **Normal** for normal hearing in normal conditions.
 - **ClearSound** (optimised) for moderate hearing impairment or use in a very noisy environment.
 - **HAC** for use with hearing aid.
2. Press **OK** to confirm.

Note! Try different settings to find the one that suits your hearing the best.

Tone setup



Select various ringtones and alerts on your device.

1. Press **Menu** → **Settings** → **Sound** → **Tone setup** → **Ringtone**.
2. Select the sound to set and select one of the available melodies, the melody will be played.
 - **Ringtone** to set the ringtone for incoming calls.
 - **Fixed ringtones** to select from pre-installed tones.
 - **More ringtones** to select from your downloads.
 - **Message tone** to set the tone for new messages.
 - **Fixed ringtones** to select from pre-installed tones.
 - **More ringtones** to select from your downloads.
 - **Keypad tone** to select the sound you hear when you press the keys of the phone.
 - **Silent:** no sound on key presses.
 - **Click:** clicking sound on key presses.
 - **Tone:** tones on key presses.
 - **Talking keys:** giving voice confirmation on key presses.
 - **Power on:** select **On** to enable the startup sound or **Off** to disable.

- **Power off:** select **Off** to enable the shutdown sound or **Off** to disable.
- **Vibration:** select vibration duration **Short** or **Long**.

Volume

Adjust the volume settings for various sounds on your device.

1. Press **Menu** → **Settings** → **Sound** → **Volume**:
2. Select type of sound and use / or the volume keys to adjust the volume.
 - **Ring volume.**
 - **Message volume.**
 - **Alarm volume.**
 - **In-call volume.**
 - **Volume lock**, see *Volume lock* , p.53.
3. Press **Save** to save.

Volume lock

When locked, volume can only be changed in the volume menus described previously.

Tip: This feature can be useful to prevent the user from accidentally changing the volume when handling the phone.

1. Press **Menu** → **Settings** → **Sound** → **Volume** → **Volume lock**:
2. Select **Unlocked/Locked** and confirm with **Yes**.

Alert type

Select to use ringtone and/or vibration for different notifications.

1. Press **Menu** → **Settings** → **Sound** → **Alert type**.
2. Select type of alert:
 - **Ringtone** for ringtone only.
 - **Vibrate** for vibration only.
 - **Silent** for no sound or vibration, the display light is lit.
 - **Ring and vibrate** for vibration and ringtone.

Bluetooth®

IMPORTANT!

If you are not using Bluetooth connectivity, switch it off to save power.
Do not pair with an unknown device.

Activate Bluetooth

1. Press **Menu** → **Settings** → **Bluetooth** → **Activation**.
2. Select **On** to activate or **Off** to deactivate.

Note! You can have several Bluetooth devices paired, but only one connected at the time. So, if one connection is active, this might block a connection from another device.

Bluetooth settings

Visibility to other devices

Note! To prevent other devices from finding your device, select **Off**. Even if you select **Off**, paired devices can still detect your device.

Your phone is visible to other Bluetooth devices as long as you have the Bluetooth activated and **Bluetooth visibility** is set to **On**.

1. Press **Menu** → **Settings** → **Bluetooth** → **Bluetooth visibility**.
2. Select **On** to make your device visible to other devices, or **Off** to be invisible.

Paired device

View already paired devices and pair new.

1. Press **Menu** → **Settings** → **Bluetooth** → **Paired device**.
2. To search and pair an available Bluetooth device in your proximity, press **Add new device** → **OK**.
3. Make sure that the device you want to connect with is within range, visible and in pairing mode.
4. Wait for the search to display the wanted device and press **Stop** when found to stop the search.
5. Select the wanted device and press **Pair** to connect. When connecting to another Bluetooth device you may need to enter a password or confirm a shared key.
6. You can also see the list of already paired devices. Select the device and press **≡** for device options.
 - **Connect/Disconnect** to connect/disconnect with the selected device.
 - **Rename(1-20)** to edit the name of the paired Bluetooth device.
 - **Delete** to delete the device from the list.
 - **Delete all** to delete all devices from the list.

- **Device details** to view detailed information about the device, e.g. device number (MAC address), device type, and supported service (Bluetooth profiles).

Transferring files

1. Press **Menu** → **Settings** → **Bluetooth** → **Transferring files**.
2. View the files being transferred via Bluetooth.

Device name

1. Press **Menu** → **Settings** → **Bluetooth** → **Device name**.
2. **DFC-0520** is displayed.
3. Edit the name.
4. Press **Save** to save the device name. This name should now appear for other Bluetooth devices.

Bluetooth file storage

You can both send and receive files via Bluetooth. Here you can set where the files received via Bluetooth should be stored. The files received via Bluetooth are normally stored in the folders corresponding to the type of file and can be displayed using the file manager, see *My files*, p.37.

1. Press **Menu** → **Settings** → **Bluetooth** → **Bluetooth file storage**.
2. Select **Phone** or **MemoryCard**.

Start-up Wizard

You can run the start-up wizard anytime you want.

Press **Menu** → **Settings** → **Start-up Wizard** and select the subject you want to change.

SIM ToolKit

Your service provider can provide some various value-added services.

Press **Menu** → **Settings** → **SIM ToolKit** → select SIM card (if applicable) for the provided services.

Software update

Check for software updates on a regular basis. Press **Software update** → **Check for update?** to check if there's a software update available and perform it. Select it to start downloading. The download time may vary depending on Internet connection. We recommend that you always update your device to the latest software version to get optimal performance and

the latest enhancements. You need to have a working data connection to be able to perform the update with the firmware over-the-air (FOTA) service. See *Data service*, p.50 on how to activate a data connection.

1. Press **Menu** → **Settings** → **Software update**.
2. Press **Check for update?** → **Yes** to check if there's a software update available.
3. Press **≡** for software update settings:
 - **Check again** to re-check for update packages to be downloaded.
 - **Version Info** to see software version information.
 - **Release notes** to see information about the software update package.
4. If there is a an update available, you will be asked if you want to download it. Press **Yes** to download the software update.
5. When download has finished, press **Yes** to install the software update.













IMPORTANT!

During an update your phone will be temporarily out of service, even for emergency calls. All contacts, photos, settings, etc. will remain safely stored in the phone. Do not interrupt the update process.









6. When the software update installation is complete, the phone will automatically restart and you will possibly need to enter your PIN code and/or phone code.
7. Press **OK** to complete the software update.

Additional functions

Display status symbols

 Signal strength	 No network coverage
 Alarm active	 Battery level
 Vibration only	 Call divert activated
 Silent	 Bluetooth on
 Voicemail message received	 Bluetooth connected
 Headset connected	 Flight mode activated
 Data transmission	

Display main symbols

 Charger connected	 Charger removed
 Error	 Query
 Warning	 Done (confirmed)
 Processing, please wait	 Battery level low
 Assistance button call	

Safety instructions



CAUTION

The unit and the accessories can contain small parts. Keep all of the equipment out of the reach of small children.

Network services and costs

Your device is approved for use on the 4G LTE FDD 1 (2100), 3 (1800), 7 (2600), 8 (900), 20 (800), 28 (700) MHz, 4G LTE TDD 38 (2600), 40 (2300), 3G UMTS 1 (2100), 8 (900) MHz, 2G GSM 900/1800 MHz networks. To use the device, you need a subscription with a service provider.

Using network services may result in traffic costs. Some product features require support from the network provider, and you may need to subscribe to the services.

Operating environment

Follow the rules and laws that apply wherever you are, and always turn off the unit whenever its use is prohibited or can cause interference or hazards (hospitals, planes, gas stations, schools, etc.). Only use the unit in its normal user position.

Parts of the unit are magnetic. The unit can attract metal objects. Do not keep credit cards or other magnetic media near the unit. There is a risk that information stored on them can be erased.

Medical units

The use of equipment that transmits radio signals, for example, mobile phones, can interfere with insufficiently protected medical equipment. Consult a doctor or the manufacturer of the equipment to determine if it has adequate protection against external radio signals, or if you have any questions. If notices have been put up at health care facilities instructing you to turn off the unit while you are there, you should comply. Hospitals and other health care facilities sometimes use equipment that can be sensitive to external radio signals.

Implanted medical devices

To avoid potential interference, manufacturers of implanted medical devices recommend a minimum separation of 15 cm between a wireless device and the medical device. Persons who have such devices should:

- Always keep the wireless device more than 15 cm from the medical device.
- Should not carry the device in a breast pocket.
- Hold the wireless device to the ear opposite the medical device.

If you have any reason to suspect that interference is taking place, turn the device off immediately. If you have any questions about using your wireless device with an implanted medical device, consult your health care provider.

Areas with explosion risk

Always turn off the unit when you are in an area where there is a risk of explosion. Follow all signs and instructions. There is a risk of explosion in places that include areas where you are normally requested to turn off your car engine. In these areas, sparks can cause explosion or fire which can lead to personal injury or even death.

Turn off the unit at filling stations, and any other place that has fuel pumps and auto repair facilities.

Follow the restrictions that apply to the use of radio equipment near places where fuel is stored and sold, chemical factories and places where blasting is in progress.

Areas with risk for explosion are often – but not always – clearly marked. This also applies to below decks on ships; the transport or storage of chemicals; vehicles that use liquid fuel (such as propane or butane); areas where the air contains chemicals or particles, such as grain, dust or metal powder.

Li-Ion battery

This product contains a Li-Ion battery. There is a risk of fire and burns if the battery pack is handled improperly.



WARNING

Danger of explosion if battery is incorrectly replaced. To reduce risk of fire or burns, do not disassemble, crush, puncture, short external contacts, expose to temperature above 60° C (140° F), or dispose of in fire or water. Never use a damaged or swollen battery. Take it to a service point or to your retailer for inspection before continuing to use it. A damaged or swollen battery may present a risk of fire, explosion or leakage or other risk. Recycle or dispose of used batteries according to the local regulations or reference guide supplied with your product.

Protect your hearing

This device has been tested to comply with the Sound Pressure Level requirement laid down in the applicable EN 50332-1 and/or EN 50332-2 standards.



WARNING

Excessive exposure to loud sounds can cause hearing damage. Exposure to loud sounds while driving may distract your attention and cause an accident. Listen to a headset at a moderate level, and do not hold the device near your ear when the loudspeaker is in use.

Emergency calls

IMPORTANT!

Mobile phones use radio signals, the mobile phone network, the terrestrial network and user-programmed functions. This means that connection cannot be guaranteed in all circumstances. Therefore, never rely only on a mobile phone for very important calls such as medical emergencies.

Vehicles

It is your responsibility to drive your vehicle safely. Never use your handheld device while driving, if it is prohibited by law.

If you must make or answer a call, stop your vehicle at a safe location first.

Radio signals can affect electronic systems in motor vehicles (for example, electronic fuel injection, ABS brakes, automatic cruise control, air bag systems) that have been incorrectly installed or are inadequately protected. Contact the manufacturer or its representative for more information about your vehicle or any additional equipment.

Do not keep or transport flammable liquids, gases or explosives together with the unit or its accessories. For vehicles equipped with air bags: Remember that air bags fill with air with considerable force.

Do not place objects, including fixed or portable radio equipment in the area above the airbag or the area where it might expand. Serious injuries may be caused if the mobile phone equipment is incorrectly installed and the airbag fills with air.

It is prohibited to use the unit in flight. Turn off the unit before you board a plane. Using wireless telecom units inside a plane can pose risks to air safety and interfere with telecommunications. It may also be illegal.

Protect your personal data

Protect your personal data and prevent leakage or misuse of sensitive information

- While using your device, be sure to back up important data.
- When disposing of your device, back up all data and then reset your device to prevent misuse of your personal information.
- Check your accounts regularly for unapproved or suspicious use. If you find any sign of misuse of your personal information, contact your service provider to delete or change your account information.
- In the event your device is lost or stolen, change the passwords on your accounts to protect your personal information.

Care and maintenance

Your unit is a technically advanced product and should be treated with the greatest care. Negligence may void the warranty.

- Protect the unit from moisture. Rain, snow, humidity, and all types of liquids can contain substances that corrode the electronic circuits. If the unit gets wet, you should immediately power off the device, remove the battery and allow the unit to dry completely before you replace it.
- Do not use or keep the unit in dusty, dirty environments. The unit's moving parts and electronic components can be damaged.
- Do not keep the unit in warm places. High temperatures can reduce the lifespan for electronic equipment, damage batteries and distort or melt certain plastics.
- Do not keep the unit in cold places. When the unit warms up to normal temperature, condensation can form on the inside and can damage the electronic circuits.
- Unauthorized modifications may damage the device, violate regulations and void the warranty. Do not try to open the unit in any other way than what is indicated in the repair manual, see doro.com/repair.
- Do not drop or shake the unit. If it is treated roughly the circuits and precision mechanics can be broken.
- Do not use chemicals or detergents to clean the unit. Use a slightly damp soft cloth.
- Do not insert any metal objects into any port on the device. You may clean a port using compressed air or by gently tapping the device against your hand with port facing down.
- Do not pull the cable when disconnecting any port as it may damage the port, cable or connector. Pull the connector.

The advice applies to the unit, battery and other accessories. If the device is not working as it should, please contact the place of purchase or Doro support for service. Don't forget the receipt or a copy of the invoice.

Warranty

This product is guaranteed for a period of 24 months and for original accessories for a period of 12 months (such as the battery, charging cradle or handsfree kit) which may be delivered with your device, from the date of purchase. In the unlikely event of a fault occurring during this period, please contact the place of purchase. Proof of purchase is required for any service or support needed during the guarantee period.

This guarantee will not apply to a fault caused by an accident or a similar incident or damage, liquid ingress, negligence, abnormal usage, non-maintenance or any other circumstances on the user's part. Furthermore, this guarantee will not apply to any fault caused by a thunderstorm or any other voltage fluctuations. As a matter of precaution, we recommend disconnecting the charger during a thunderstorm.

Please note that this is a voluntary manufacturer's warranty and provides rights in addition to, and does not affect statutory rights of end-users.

This guarantee does not apply if batteries other than DORO original batteries are used.

Device OS software warranty

By using the device, you accept to install any OS software updates provided by Doro, at earliest possibility.

By updating your device, you help to maintain your device secure.

Doro will keep updates available for the duration of the guarantee/ statutory warranty period, providing that this is possible from a commercial and technical perspective.

Please note:

- In some cases, regular OS upgrades may cause delays to planned security updates.
- Doro will always do our best to deliver the security updates at earliest possible time to applicable models. Delivery time of security patches may vary depending on the regions, software variants and models.



CAUTION

If you neglect to update your device, it may void your guarantee of the device. For software information and planned update schedule, refer to website: doro.com/softwareupdates

Specifications

Network bands (MHz):	
2G GSM	900, 1800
3G UMTS	1 (2100), 8 (900)
4G LTE FDD	1 (2100), 3 (1800), 7 (2600), 8 (900), 20 (800), 28 (700)
4G LTE TDD	38 (2600), 40 (2300)
Bluetooth (MHz):	5.0, (2402 - 2480)
SIM card size:	nano-SIM (4FF)
Memory card size:	128 GB (microSD, microSDHC, microSDXC)
Dimensions:	107 mm x 56 mm x 20 mm
Weight:	131 g (including battery)
Battery:	3.7 V / 1150 mAh Li-ion battery
Charging:	USB-C, 5 V
Dust and water protection:	IP54
Operating ambient temperature:	Min: 0° C (32° F) Max: 40° C (104° F)
Charging ambient temperature:	Min: 0° C (32° F) Max: 40° C (104° F)
Storage temperature:	Min: -20° C (-4° F) Max: 60° C (140° F)

Copyright and other notices

Bluetooth® is a registered trademark of Bluetooth SIG, Inc.

vCard is a trademark of the Internet Mail Consortium.

microSD is a trademark of SD Card Association.

The contents of this document are provided "as is". Except as required by applicable law, no warranties of any kind, either express or implied, including, but not limited to, the implied warranties of merchantability and fitness for a particular purpose, are made in relation to the accuracy, reliability or contents of this document. Doro reserves the right to revise this document or withdraw it at any time without prior notice.

Other product and company names mentioned herein may be the trademarks of their respective owners.

Any rights not expressly granted herein are reserved. All other trademarks are property of their respective owners.

To the maximum extent permitted by applicable law, under no circumstances shall Doro or any of its licensors be responsible for any loss of data or income or any special, incidental, consequential or indirect damages howsoever caused.

Doro does not provide a warranty for or take any responsibility for the functionality, content, or end-user support of third-party apps provided with your device. By using an app, you acknowledge that the app is provided as is. Doro does not make any representations,

provide a warranty, or take any responsibility for the functionality, content, or end-user support of third-party apps provided with your device.

Content copyright

The unauthorised copying of copyrighted materials is contrary to the provisions of the Copyright Laws of the United States and other countries. This device is intended solely for copying non-copyrighted materials, materials in which you own the copyright, or materials which you are authorised or legally permitted to copy. If you are uncertain about your right to copy any material, please contact your legal advisor.

Hearing aid compatibility

Note! For hearing aid compatibility, turn off Bluetooth connectivity.

This phone is hearing aid compatible. Hearing aid compatibility is not a guarantee that a specific hearing aid will work with a specific phone. Mobile phones contain radio transmitters that may interfere with hearing aid performance. This phone has been tested for use with hearing aids, for some of the wireless technologies that it uses, but there may be some newer wireless technologies that have not been tested yet for use with hearing aids. To ensure that a specific hearing aid works well with this phone, test them together before making a purchase.

The standard for hearing aid compatibility contains two types of ratings:

- **M:** To use your hearing aid in this mode, make sure that your hearing aid is set to "M-mode" or acoustic coupling mode, and position the phone's receiver near the hearing aid's built-in microphone. For the best results, try using the phone in different positions relative to your hearing aid—for example, placing the receiver slightly above the ear may result in better performance for hearing aids with microphones positioned behind the ear.
- **T:** To use your hearing aid in this mode, make sure that your hearing aid is set to "T-mode" or telecoil coupling mode (not all hearing aids have this mode). For the best results, try using the phone in different positions relative to your hearing aid—for example, placing the receiver slightly below or in front of the ear may result in better performance.

Your device meets the M3/T4 level rating.

Specific Absorption Rate (SAR)

This device meets applicable international safety requirements for exposure to radio waves. Your mobile device is a radio transmitter and receiver. It is designed not to exceed the limits for exposure to radio waves (radio frequency electromagnetic fields) recommended by international guidelines from the independent scientific organization ICNIRP (International Commission of Non-Ionizing Radiation Protection).

The World Health Organization (WHO) has stated that current scientific information does not indicate the need for any special precautions when using mobile devices. If you are interested in reducing your exposure, they recommend you reduce your usage or use a hands-free accessory to keep the device away from your head and body.

For information about SAR (Specific Absorption Rate) values for your device, please read the documentation provided together with your device.

Recycle

Doro takes responsibility for the entire life cycle of our products including how they are recycled at end of their life. Your previous product can still be useful for someone else and, if it has reached its end of life, materials that can be used for new products. We recommend to first-hand reuse, repair or refurbish your device, and if this is not possible leave it for recycling according to local regulations. Also remember to recycle other old non-used electronics that you might have.

Correct disposal of this product



(Waste Electrical & Electronic Equipment)

(Applicable in countries with separate collection systems)

This marking on the product, accessories or manual indicates that the product and its electronic accessories (e.g. charger, headset, USB cable) should not be disposed of with other household waste. To prevent possible harm to the environment or human health from uncontrolled waste disposal, please separate these items from other types of waste and recycle them responsibly to promote the sustainable reuse of material resources. Household users should contact either the retailer where they purchased this product, or their local government office, for details of where and how they can take these items for environmentally safe recycling. Business users should contact their supplier and check the terms and conditions of the purchase contract. This product and its electronic accessories should not be mixed with other commercial wastes for disposal. This product is RoHS compliant.

Correct disposal of batteries in this product



(Applicable in countries with separate collection systems)

The marking on the battery, manual or packaging indicates that the battery in this product should not be disposed of with other household waste. If batteries are not properly disposed of, these substances can cause harm to human health or the environment.

To protect natural resources and to promote material reuse, please separate batteries from other types of waste and recycle them through your local, free battery return system.

EU Declaration of Conformity

Hereby, Doro declares that the radio equipment type DFC-0520 (Doro Leva L21) is in compliance with Directives: 2014/53/EU and 2011/65/EU including delegated Directive (EU) 2015/863 amending Annex II. The full text of the EU declaration of conformity is available at the following internet address: www.doro.com/dofc.

If a power adapter is supplied with your device:

Ecodesign declaration, energy efficiency for external power supply

Hereby, Doro declares the external power supply for this device is in compliance with Commission Regulation (EU) 2019/1782 regarding ecodesign requirements for external power supplies pursuant to Directive 2009/125/EC.

The full information regarding the ecodesign requirements is available at the following internet address: www.doro.com/ecodesign

UK Declaration of Conformity

Hereby, Doro declares that the radio equipment type DFC-0520 (Doro Leva L21) is in compliance with the relevant UK legislation.

The full text of the UK declaration of conformity is available at the following internet address: www.doro.com/dofc

DFC-0520 (Doro Leva L21)

English

Version 2.0

©2024 Doro AB. All rights reserved.

www.doro.com



REV 22530 – STR 20240708