

Doro HearingBuds

English

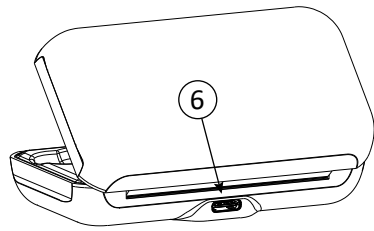

doro

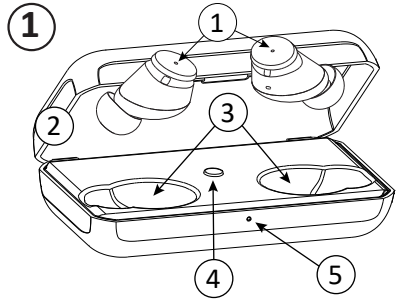
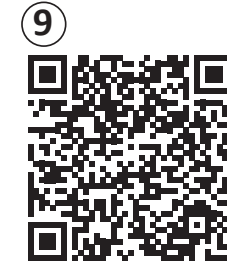
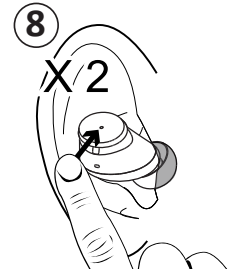
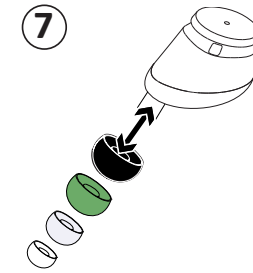
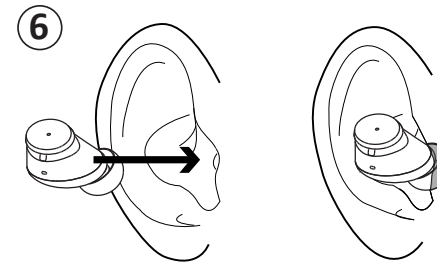
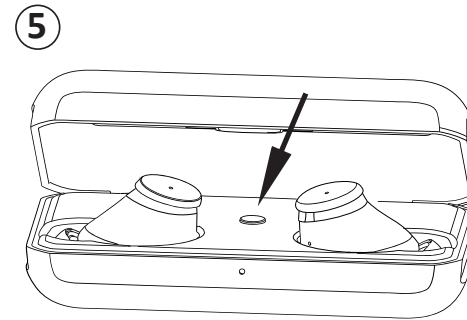
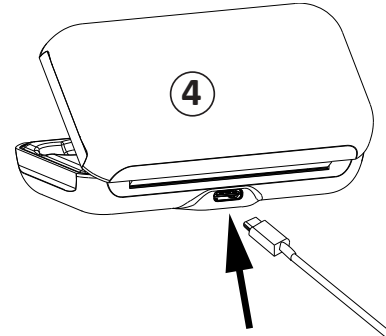
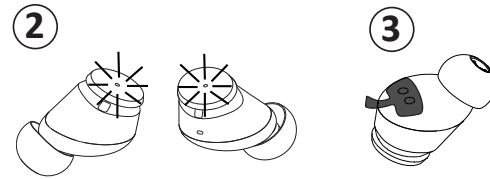

GET IT ON
Google Play



Download on the
App Store

ENGLISH

QUICK START GUIDE

① Overview

1. Earbuds
2. Charging case
3. Earbuds, charging slots
4. Pairing button
5. Indication light
6. USB Type-C, for battery charging

Doro HearingBuds are advanced, true wireless earphones designed with sound experience enhancement technology to reduce unwanted noise and to make conversation, calls and listening to music both clearer and more comfortable. For the full manual please visit www.doro.com/support/ and search for **Doro HearingBuds** or contact our Helpline.

Get used to the HearingBuds

The human ear is very complex.

- Some things will sound strange at first, but give yourself time to adjust this new sound.
- We recommend wearing your HearingBuds every day, but remember to take regular breaks.
- Try your HearingBuds out in different environments.

Important:

Doro HearingBuds is not a medical device, but the earbuds have functionality to improve sound in different situations.

Requirements

For using **Doro HearingBuds app**, that allows you to customize the earbuds sound enhancement according to your specific hearing ability you need:

- Android version 8 or later
OR iOS version 14 or later
- A Google account
OR an Apple-ID to be able to download and install the Doro HearingBuds app.

② & ③ Before first use

Make sure the lights on your earbuds are activated when you open the case. If not, remove the small plastic strip on the charging contacts of the earbuds. We recommend that you charge the case and the earbuds before you use them the first time.

④ Charging

Note: For environmental reasons this package does not include a charger. The power delivered by the charger must be between minimum 2.5 Watts required by the radio equipment, and maximum 5 Watts in order to achieve the maximum charging speed. You may use chargers with higher power, but it will not increase the charging speed.

When the earbuds are in the case they will automatically charge. To charge the case, insert a USB-C cable and connect to a power source that has been CE or UKCA certified.

When the case is charging the light on the front of the case will blink slowly.

You can tell if you need to charge the case by looking at the light on front of the case:

- Steady green light = case is fully charged
- Orange light = battery status about 20-80%
- Red light = 5-20% battery capacity
- Red and flashing light = battery level is critical (0-5%).

⑤ Pair with a connecting device

Important

The HearingBuds must be placed in the charging case before the pairing process is started.

1. Start by activating Bluetooth on your connecting device. On most devices you can find this under **Settings** → **Bluetooth**
2. Open the case. Press and hold the **pairing button** inside the case for two seconds. The light on the front of the case will start to blink blue.
3. Take the earbuds out of the case.

Note! If your connecting device supports **Google Fast Pair**, **Doro HearingBuds** will automatically show up for connection. Select **Connect/Pair** to pair.

4. On your connecting device, go to Bluetooth settings. Select "**Doro HearingBuds**" in the list of available Bluetooth devices and select **Connect /Pair** or similar. Should pairing fail or you want to pair the earbuds with a different device, repeat the previous steps.

⑥ Wear your HearingBuds

Make sure the HearingBuds fit comfortably in your ears. Gently insert the silicone tip into the ear canal and position the flat part (with the charging contacts) on the outer ear. You do not have to think about what bud is for your right or left ear. The earbuds have an automatic left/right ear detection.

Tip: Try gently pulling the top of your outer ear up to aid fitting them correctly and comfortably. Try different size of the ear tips provided. To ensure a better sound experience, pick the tip size that seals and fits the best with your ear canal.

⑦ Change silicone ear tip

Included in the package are different tips. If the earbuds does not fit, try to change to a larger or smaller tip.

⑧ HearingBuds control

To play/pause what you are listening to, or to answer/hang up a call, tap twice on one of the earbuds.

How to handle and clean your earbuds



The silicone ear tips are designed so that dirt and ear wax are prevented to get into the sound canals of the earbuds. To clean, use a slightly damp cloth, or if needed, carefully remove the silicone tip and clean with mild soap and lukewarm water.

Do not use solvents when cleaning.

How to install and use the Doro HearingBuds app

HearingBuds app

1. Scan the QR code above with a QR reader in your mobile device. This will take you to a web page where you can download the **Doro HearingBuds app**. Scan:

-  for Google Play store
-  for Apple App Store

2. Install the app like you normally install apps.

In the app there are several settings that you can use to optimise your HearingBuds.

Safety instructions

⚠ CAUTION

The unit and the accessories can contain small parts. Keep all of the equipment out of the reach of small children. The mains adapter is the disconnect device between the product and mains power. The mains socket outlet must be close to the equipment and easily accessible.

Your unit is a technically advanced product and should be treated with the greatest care. Negligence may void the warranty.

- Protect the unit from moisture. Rain, snow, humidity, and all types of liquids can contain substances that corrode the electronic circuits.
- Do not use or keep the unit in dusty, dirty environments.
- Do not keep the unit in warm or cold places.
- Do not drop the unit. Do not knock or shake it either. If it is treated roughly the circuits and precision mechanics can be broken.
- Do not use strong chemicals to clean the unit.

The advice above applies to the unit and other accessories. If the unit is not working as it should, please contact the place of purchase for service. Don't forget the receipt or a copy of the invoice.

Li-Ion battery

This product contains a Li-Ion battery. There is a risk of fire and burns if the battery pack is handled improperly.

⚠ WARNING

Danger of explosion if battery is incorrectly replaced. To reduce risk of fire or burns, do not disassemble, crush, puncture, short external contacts, expose to temperature above 60° C (140° F), or dispose of in fire or water. Do not charge the battery unattended. Recycle or dispose of used batteries according to the local regulations or reference guide supplied with your product.

Correct disposal of this product

 (Waste Electrical & Electronic Equipment)
(Applicable in countries with separate collection systems)

This marking on the product, accessories or manual indicates that the product and its electronic accessories (e.g. charger, USB cable) should not be disposed of with other household waste. To prevent possible harm to the environment or human health from uncontrolled waste disposal, please separate these items from other types of waste and recycle them responsibly to promote the sustainable reuse of material resources.

Household users should contact either the retailer where they purchased this product, or their local government office, for details of where and how they can take these items for environmentally safe recycling.

Business users should contact their supplier and check the terms and conditions of the purchase contract. This product and its electronic accessories should not be mixed with other commercial wastes for disposal. This product is RoHS compliant.

Correct disposal of batteries in this product

 (Applicable in countries with separate collection systems)
The marking on the battery, manual or packaging indicates that the battery in this product should not be disposed of with other household waste. If batteries are not properly disposed of, these substances can cause harm to human health or the environment. To protect natural resources and to promote material reuse, please separate batteries from other types of waste and recycle them through your local, free battery return system.

EU declaration of conformity

Hereby, Doro declares that the radio equipment type DWO-0430 (Doro HearingBuds) is in compliance with Directive 2014/53/EU and other applicable legislations.

The full text of the EU declaration of conformity is available at the following internet address: www.doro.com/dofc.

Technical support details

Technical support is available by email on support.uk@doro.com or telephone number: 0800 026 5479 (UK) / 01 699 0983 (Ireland)

calls are charged at your standard local network rates.

UK contact address for legal matters: Doro UK Ltd, Suite 025, Thames Valley Park, 400 Thames Valley Park Drive, Earley, Reading, RG6 1PT, UK

Further contact details are available on our website: www.doro.co.uk.

See www.doro.com for Ireland.

UK declaration of conformity

Hereby, Doro declares that the radio equipment type DWO-0430 (Doro HearingBuds) is in compliance with directive RER 2017 and other relevant UK legislation. The full text of the UK declaration of conformity is available at the following internet address: www.doro.com/dofc

Removing/replacing the battery

- To remove/replace the battery, contact an authorised service centre. Please find latest information at www.doro.com.
- For your safety, you must not attempt to remove the battery. If the battery is not properly removed, it may lead to damage to the battery and device, cause personal injury, and/or result in the device being unsafe.
- Doro does not accept liability for any damage or loss if these warnings and instructions are not followed.

Protect your hearing

 Excessive sound pressure from earphones and headphones can cause hearing loss.

Warranty

This product is guaranteed for a period of 24 months from the date of purchase. In the unlikely event of a fault occurring during this period, please contact the place of purchase. Proof of purchase is required for any service or support needed during the guarantee period.

This guarantee will not apply to a fault caused by an accident or a similar incident or damage, liquid ingress, negligence, abnormal usage, non-maintenance or any other circumstances on the user's part. Furthermore, this guarantee will not apply to any fault caused by a thunderstorm or any other voltage fluctuations.

Please note that this is a voluntary manufacturer's warranty and provides rights in addition to, and does not affect statutory rights of end-users.

Device software warranty

By using the device, you accept to install any OS software updates provided by Doro, at earliest possibility after notification. By updating your device, you help to maintain your device secure. Doro will keep updates available for the duration of the guarantee/ statutory warranty period, providing that this is possible from a commercial and technical perspective. Your device checks for available software updates automatically. Please follow the on-screen instructions when you are notified of an software update.

Specifications

Bluetooth, version (MHz)	
[maximum transmit power, dBm]:	5.0 (2 402–2 480) [2.07]
Dimensions	Case: 88 x 47 x 26 mm
	Buds: 16 x 17 x 20 mm
Weight	Case: 57 g (including battery)
	1 Bud: 6 g
Battery	Case: 3.7 V / 700 mAh Li-Ion
	1 Bud: 3.7 V / 85 mAh Li-Ion
Charging time	Case: 3 h
	Buds: 105 min.
Battery Life	Case: 2 full charges of 2 earbuds
	Buds: Up to 11 h
Waterproof:	Case: –
	Buds: Drip protected (IP52)
Operating ambient temperature:	Min: -5 °C
	Max: 45 °C
Charging ambient temperature:	Min: -5 °C
	Max: 40 °C

Bluetooth® and the Bluetooth® logo are registered trademarks of Bluetooth SIG, Inc.

This device is a low-power radio transmitter and receiver. As recommended by international guidelines, the device meets applicable national SAR limits of 2.0W/kg (10g). 10g SAR: meets low-power exclusion level, SAR test is not required.

This product can be used across EU member states.

Please note:

- In some cases, regular OS upgrades may cause delays to planned security updates.
- Doro will always do our best to deliver the security updates at earliest possible time to applicable models. Delivery time of security patches may vary depending on the regions, S/W variants and models.

⚠ CAUTION:

If you neglect to update your device after being notified, it may void your guarantee of the device. For software update planned schedule, refer to website: doro.com/softwareupdates

Recycle

Doro takes responsibility for the entire life cycle of our products including how they are recycled at end of their life. Your previous product can still be useful for someone else and, if it has reached its end of life, materials that can be used for new products. We recommend to first-hand reuse, repair or refurbish your device, and if this is not possible leave it for recycling according to local regulations. Also remember to recycle other old non-used electronics that you might have.

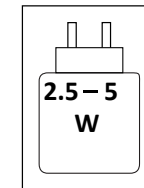

Model: DWO-0430
Doro HearingBuds (2011, 2021, 3011)
English (EN)

QSG_Doro_HearingBuds_78x103_en_v20_I2870270B58P001